

Yihui Casting® 艺辉

艺辉铸造科技有限公司是 Yihui Casting® 艺辉 注册商标的专用权人，
经艺辉铸造科技有限公司许可授权瑞辉自动化系统（广东）有限公司使用。

Yihui Casting Technology Co., Ltd. hold and reserve exclusive right of Yihui Casting® 艺辉

授权方 Authorized Party ■

艺辉铸造科技有限公司

Yihui Casting Technology Co., Ltd.

地址: 广东省广州市番禺区沙头街沙南路50号

Add.: No.50, Shan'an Road, Shatou Street, Panyu District, Guangzhou City,
Guangdong Province, China

电话/ Tel: +86-20-34734999/34734666 传真/Fax: +86-20-84872122

邮箱/Email: info@yihuicasting.com

网址/ Web: www.yihuicasting.com www.yihuicasting.cn

制造商 Agency ■

瑞辉自动化系统(广东)有限公司

Ruihui Auto System (Guangdong) Co. Ltd.

地址: 广东省广州市番禺区沙湾镇福涌牛眠岗工业区一街10号

Add.: No.10, First Street, Niutang Industrial Park, Fuchong, Shawan
Town, Panyu District, Guangzhou City, Guangdong province, China

双温控电炉 Burnout oven (Double control)



专注于首饰铸造
Specializing In Jewelry Casting

专业 敬业 合作 共赢
profession Dedication Cooperation Double-win

五、高温电炉基本参数
Basic parameters of high temperature burnout oven (Double control)

名称 Description	型号 Model	功率 Power input	电压 Voltage	最高温度 Maimum Temperature	工作温度 Working Temperature	外形尺寸 Outline size	炉膛尺寸 Internal Size	重量 Weight
4盘4×9双温控不锈钢电炉 4PCS Masks Oven (double control)	M.BO.BB004	3KW	220V	1000°C	750-850°C	73×80×124cm	32×34×32cm	160kg
6盘4×9双温控不锈钢电炉 6PCS Masks Oven (double control)	M.BO.BB006	4KW	220V	1000°C	750-850°C	73×93×124cm	32×48×32cm	180kg
12盘4×9双温控不锈钢电炉 12PCS Masks Oven (double control)	M.BO.BB012	6KW	380V	1000°C	750-850°C	73×93×157cm	32×48×59cm	210kg
18盘4×9双温控不锈钢电炉 18PCS Masks Oven (double control)	M.BO.BB018	8KW	380V	1000°C	750-850°C	87×93×157cm	46×48×59cm	245kg
24盘4×9双温控不锈钢电炉 24PCS Masks Oven (double control)	M.BO.BB024	9KW	380V	1000°C	750-850°C	87×106×162cm	46×60×59cm	350kg
32盘4×9双温控不锈钢电炉 32PCS Masks Oven (double control)	M.BO.BB032	10.5KW	380V	1000°C	750-850°C	100×106×162cm	59×60×59cm	430kg
40盘4×9双温控不锈钢电炉 40PCS Masks Oven (double control)	M.BO.BB040	12KW	380V	1000°C	750-850°C	100×120×162cm	60×74×59cm	500kg

四、注意事项 Precautions:

- 1.开机前请检查电源供电情况。
- 2.安放工件时，应安放整齐，不能超出底盘面积。
- 3.所放工件切勿接触到发热元件，以防发热元件损坏。
- 4.本机脱蜡口位于炉底中心处，可用盘类盛器装清水置于炉底下回收。
- 5.本机随机配件有烟筒若干个，使用前需把烟筒放入炉顶出气孔，以防工件中的水蒸气进入保温层
- 6.遇其他更多情况请联系生产商或经销商，机身配件以及控制电箱除人为破坏和操作不当或不可抗拒因素外保用一年，发热元件除外。

- 1.Please check the power supply before starting.
- 2.When placing the workpiece, it should be placed neatly and cannot exceed the area of the chassis.
- 3.Do not put the workpiece in contact with the heating element to prevent damage to the heating element.
- 4.The dewaxing port of this machine is located at the center of the furnace bottom, and a tray container can be filled with clean water and placed under the furnace for recovery.
- 5.The machine comes with several chimneys as accessories. Put the chimney into the vent hole on the top of the oven before use, in order to prevent water vapor in the workpiece from entering the insulation layer.
- 6.In other cases, please contact the manufacturer or distributor. The body parts and control box are guaranteed for one year except for man-made damage, improper operation or force majeure, except for heating elements.

注释：本机所配置温控表为XMTC(B)系列智能温控仪表，详细设置请参考附该表独立说明书。

Note: The temperature control meter equipped with this machine is XMTC(B) series intelligent temperature control meter.

For detailed settings, please refer to the separate manual attached to the meter.

目录 CONTENTS

声明 STATEMENTS	1
一、新机安装说明 New machine installation instructions	2
二、使用说明 Usage instruction	3
三、简易自行维修 Maintenance	10
四、注意事项 Precautions	11
五、高温电炉基本参数 Basic parameters of high temperature burnout oven (Double control)	12

声明

致用户：

- 感谢您对瑞辉自动化系统 (广东) 有限公司的信赖和支持，选购艺辉牌系列产品，为安全操作并最大限度发挥本机性能，请在操作前仔细阅读说明书，并严格遵守安全规则，以防发生意外事故，造成不必要的损失。
- 在机器使用的过程中，如遇到问题可以随时联系本公司销售人员，我们将会竭诚为您服务。
- 在保修期间，如果未经本公司允许，用户不得擅自拆开机器进行错误的检修，如擅自拆开机器，保修期将自动失效，不再享受本公司保修服务。
- 机器使用时所产生损失、利益损失和各种违规操作造成的各种间接损害，概与本公司无关。
- 未经本公司许可，产品说明书的所有内容，不得以任何形式翻版、传播、转载。
- 说明书因修改而进行的变更，恕不另行通知。如果您发现任何错误或遗漏，请向您所购买的供应商反映，对此，我们深表感谢。

STATEMENT

To users:

- Thanks for choosing Yihui brand products of Yihui Casting Technology Co.,Ltd. We are greatly appreciated for the support and trust you give to us. To ensure safe operation and play the property of this machine in full, please read the user manual in advance and observe the safty rules in case that accidents happen and unnecessary loss incurrus.
- If you meet any problem when using this machine, please feel free to contact our salespersons. We will try our best to give you service.
- We are not responsible for the loss including loss in interest and all indirect damages caused by operations due to rule-breaking operations.
- Without our permittion, it is prohibited to copy,disseminate or reprint the whole content of this user manual in any form.
- This manual is subject to alterations without prior notice. If you find any mistake or omission in this manual, please inform the supplier you bought the machine from. We will be very grateful for this.

版本号：V1.0 2020.07.27

三、简易自行维修 Maintenance:

本机发热元件拆装方便，为不影响生产需要，可自行从生产商或经销商处购买，以备日后快速自行更换，保证日常生产。

- 1.关上电源，拆开本机后面封板，扭开对应螺丝，把坏或旧发热元件从炉膛内取出，把新的发热元件按炉膛设计拉伸到合适长度装上，按拆卸步骤装回即可
- 2.换上新发热元件时需把安放发热元件的凹槽清理干净，或用耐高温绝缘的垫片隔离凹槽中的导电物，以防发热元件再次烧坏。
- 3.炉后的接线柱放置的绝缘陶瓷切勿丢失，切记每次更换完毕验查，不可缺失！
- 4.本机发热元件分为3组，如发热元件需要更换时，务必把发热元件分整组，以保证新发热元件与另2组发热元件负载平衡。

The heating element of this machine is easy to disassemble and assemble. In order not to affect the production needs, you can buy it from the manufacturer or dealer for quick replacement in the future to ensure daily production.

- 1.Turn off the power, disassemble the sealing plate on the back of the machine, unscrew the corresponding screws, take out the broken or old heating element from the furnace, stretch the new heating element according to thefurnace design to a suitable length, install it, and install it according to the disassembly steps.
- 2.When replacing a new heating element, clean the groove where the heating element is placed, or isolate the conductive object in the groove with a high-temperature insulation gasket to prevent the heating element from burning out again.
- 3.Do not lose the insulating ceramic placed on the terminal post behind the oven, remember to check after each replacement, and not to be missing!
- 4.The heating elements of this machine are divided into 3 groups. If the heating elements need to be replaced, be sure to divide the heating elements into groups to ensure that the new heating elements are load balanced with the other two heating elements.

6. Same as above, follow steps 2 and 3 to set the temperature and time of the next stage number. Note that the last stage should be set as the heat preservation segment, and the time to be set should be as long as possible to ensure that the temperature in the furnace of the machine is not Change to meet the needs of the mold.
7. After setting the required temperature and time, press and hold the set button "set" for about 3 seconds, and release it when the SV displays the word "stop". At this time, the setting is completed and the data has been saved, click Standby key "◀", the machine will return to working state according to the latest setting data.
8. Every time the power is turned off and restarted, the machine will start working from the first stage according to the setting data, and there is no need to reset it every time it is used.

选段使用:

由于每次关闭电源从新开机后,本机都会按照已设置数据从第一段开始工作,所以日常使用中遇到人为不小心关掉电源又从新操作的操作失误,如本机已进行第三段工作,炉内温度已达到400℃,此时不小心出现上述人为失误时,使得机器从新从第一段开始烧起,与生产所需不符合,此时可通过选段操作进行调整,操作如下:

- 1.在本机工作状态下同时按设置键"set"和移位键"◀",SV显示正在工作段段号,如"P--0",此时通过移位键以及增加键或减少键选择所需段号,如增加到"P--2",即选择第三段数据进行工作。
- 2.选好段号后,按设置键"set",回到正常工作状态,本机按所选段对应数据工作。

Stage usage:

Since every time the power is turned off and restarted, the machine will start to work from the first stage according to the setting data. In daily use, we encounter man-made mistakes in turning off the power and restarting the operation. For example, the machine has been in the third stage ,Oven working temperature has reached 400 °C, and the above-mentioned human error accidentally caused the machine to start burning from the first stage, which does not meet the production requirements. At this time, you can adjust through the stage operation. The operation is as follows:

1. Press the setting key "set" and the shift key "◀" at the same time in the working state of the machine, SV displays the number of the working stage, such as "P-0". at this time, use the shift key and the increase key or the decrease key to select If the required segment number is increased to "P-2", the third stage of data will be selected for working.
2. After selecting the segment number, press the set key "set" to return to the normal working state, and the machine will work according to the corresponding data of the selected segment.

一、新机安装说明 New machine installation instructions

1.本机本机配备独立控制电箱。电箱背部安装说明图如下:

1.This machine is equipped with an independent control electric box. The installation instructions on the back of the electrical box are as follows:

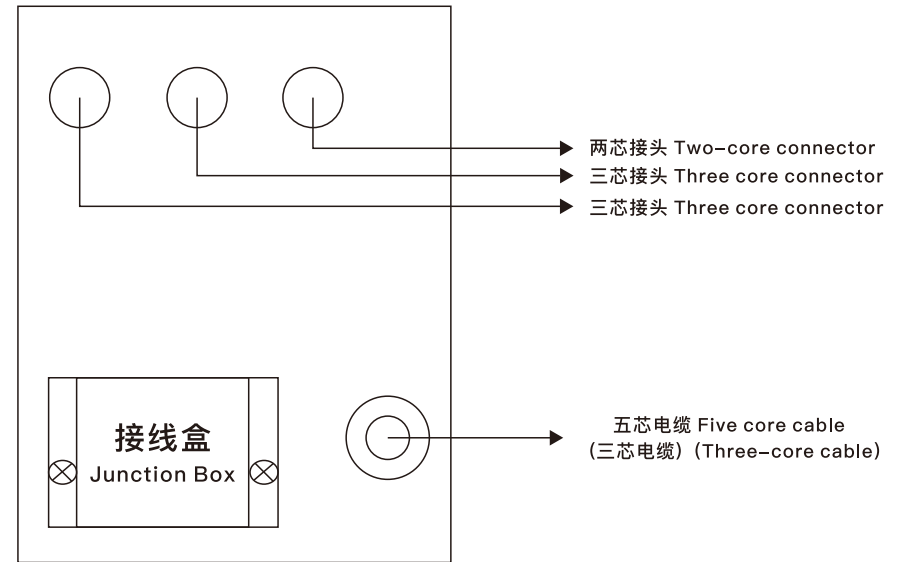

- 2.把电箱放在炉架托盘上,用十字螺丝刀打开接线盒,把电炉左侧的三条(两条)白色高温线分别接到接线盒上接线柱上,然后上回螺丝。
- 3.型号为M.BO.BB0(12--40)#都配备电缆为国标6平方五芯电缆,分别是3条火线1条零线和1条地线,其中3个接头为“Y”型线头的为火线,不带线头的蓝色线为零线,黄绿相间的为地线,分别接到电源开关上。
- 4.型号为M.BO.BB0(4--6)#配备电缆为国标4平方三芯电缆,分别是1条火线1条零线和1条地线,其中接头为“Y”型线头的为火线,不带线头的蓝色线为零线,黄绿相间的为地线,分别接到电源开关上。
- 5.把电炉左侧的两条探温棒线与行程开关线分别插入两个三芯接头(注:不分主次)与两芯接头内,并上紧。
- 6.接线时,应先检查电源负载以保证本机正常工作中所需负荷,以上操作须由电工完成。

1. Put the electric box on the Oven tray, use a Phillips screwdriver to open the junction box, and connect the three (two) white high temperature wires on the left side of the electric furnace to the wiring posts on the junction box, and then screw them back.
2. Model M.BO.BB0(12--40)# is equipped with a national standard 6 square five-core cable, which are 3 live wires, 1 neutral wire and 1 ground wire, and 3 of them are with "Y" type heads. It is a live wire, the blue wire without a wire end is the neutral wire, and the yellow and green wire is the ground wire, which should be connected to the power switch.
3. The model is M.BO.BB0(4--6)# The equipped cable is a national standard 4-square three-core cable, which is 1 live wire, 1 neutral wire and 1 ground wire, and the connector which is a "Y" type wire end is the live wire, the blue wire without a wire end is the neutral wire, and the yellow and green wires are the ground wires. They should be respectively connected to the power switch.
4. Insert the two temperature probe wires and the travel switch wires on the left side of the electric furnace into the two three-core connectors (note: regardless of primary and secondary) and two-core connectors, and tighten them.
5. When wiring, check the power load first to ensure that the machine needs to work normally. The above operations must be completed by an electrician.

二、使用说明 Usage instruction :

控制电箱说明图:

Diagram of control electric box:

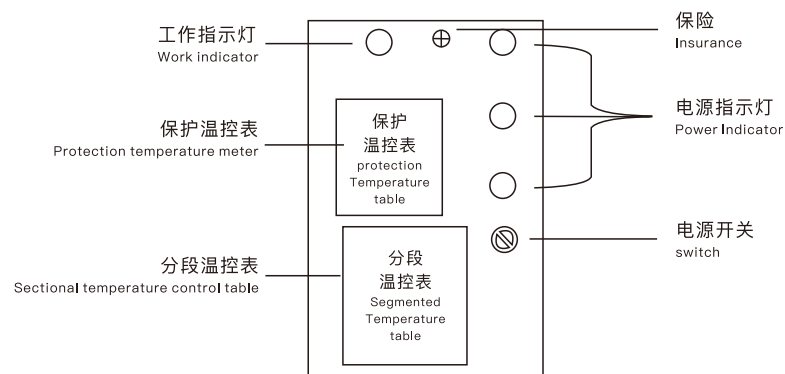

若要设置其它焙烧数据,可按如下简易操作:

1. 打开电源, 按下待机键“◀”进入待机状态, 此时进入设置预备状态。
2. 按下设置键“set”, PV显示“P—0”, 指接下来设置数据为第一段数据, 再按下设置键, PV显示“C--0”, 此时通过移位键以及增加或减少设置SV中显示的第一段所需温度。
3. 按先设置键, PV显示“t--0”, SV显示“120”, 此时通过移位键以及增加键或减少键设置第一段温度煅烧时间。
4. 再按下设置键, PV显示“P—1”, 指接下来设置数据为第二段数据, 再按下设置键, PV显示“C--1”, 此时通过移位键以及增加或减少设置SV中显示的第二段所需温度。
5. 按先设置键, PV显示“t--1”, SV显示“120”, 此时通过移位键以及增加键或减少键设置第二段温度煅烧时间。
6. 同上, 按照2、3步设置接下来所要设置段号的温度与时间, 注意, 最后一段应该作为保温段设置, 所要设置的时间尽量长, 以保证进行倒模工作本机炉膛内温度不变, 以满足倒模所需。
7. 当把所需的温度与时间都设置完后, 按住设置键“set”约3秒钟, SV显示“stop”字样时放开, 此时本次设置完毕, 数据已保存, 按一下待机键“◀”, 本机按照最新设置数据回到工作状态。
8. 每次关闭电源从新开机后, 本机都会按照已设置数据从第一段开始工作, 无需每次使用都从新设置一次

If you want to set other roasting data, you can operate simply as follows:

1. Turn on the power, press the standby key “◀” to enter the standby state, and enter the setting preparation state at this time.
2. Press the setting key “set”, PV displays “P-0”, which means that the setting data is the first stage of data, and then press the set key, PV displays “C--0”, at this time, press the shift key And increase or decrease the required temperature of the first segment displayed in the setting SV.
3. Press setting key, PV displays “t--0”, SV displays “120”, and at this time, use the shift key and the increase key or the decrease key to set the first temperature calcination time.
4. Press the set button again, PV displays “P-1”, which means that the setting data is the second stage data, and then press the setting button, PV displays “C--1”, at this time, press the shift key and increase Or reduce the temperature required to set the second stage displayed in SV.
5. Press the first setting key, PV displays “t--1”, SV displays “120”, at this time, set the second temperature calcination time through the shift key and the increase key or the decrease key.

注释 Notes:

本机配备的分段控温表，出厂初始设置如下：

The stage temperature control meter equipped with this machine has the following factory initial settings:

	P (段号 Stage number) --0	P--1	P--2	P--3	P--4	P--5
C (温度 Tempera ture)	150°C	250°C	400°C	600°C	730°C	650°C
t (时间 Time)	120min	120min	90min	100min	180min	1000min

注解：

P--0：为第一段，温度150°C，时间设置120min；

P--1：为第二段，温度250°C，时间设置120min；

P--2：为第三段，温度400°C，时间设置90min；

P--3：为第四段，温度600°C，时间设置100min；

P--4：为第五段，温度730°C，时间设置180min；

P--5：为第六段，温度650°C，时间设置1000min；

Notes:

P--0: It is the first stage, the temperature is 150°C, and the time is set to 120min;

P--1: It is the second stage, the temperature is 250°C, and the time is set to 120min;

P--2: It is the second stage, the temperature is 400°C, and the time is set to 90min;



P--3: It is the third stage, the temperature is 600°C, and the time is set to 100min;

P--4: It is the fourth stage, the temperature is 730°C, and the time is set to 180min;

P--5: It is the fifth stage, the temperature is 650°C, and the time is set to 1000min;

说明图标注：

Description icon Note:

- 1.电源指示灯：红色，当三相电都接上后三个指示灯亮起，表示本机电源已接通。
- 2.工作指示灯：绿色，指示灯亮起时，表示本机已进入工作状态。
- 3.保险：电箱保险，保护控制电箱内部电路。
- 4.分段温控表：设置和控制本机升温过程。
- 5.保护温控表：设置本机使用最高温度，如本机使用到的温度为730°C，则设置730°C即可，主要作用为防止超温造成产品损坏，起保护作用。
- 6.“
 - 1.Power indicator: red, when the three-phase power is connected, the three indicator lights will light up, indicating that the power of the machine is connected.
 - 2.Working indicator light: Green, when the indicator light is on, it means that the machine has entered the working state.
 - 3.Insurance: The electric box insurance protects the internal circuit of the control electric box.
 - 4.Sectional temperature control meter: setting and control the heating process of the machine.
 - 5.Protection temperature control meter: set the maximum temperature of the machine. If the temperature used by the machine is 730°C, set 730°C. The main function is to prevent product damage caused by over-temperature and play a protective role.
 - 6.“

分段温控表简易操作说明：
Simple operation instructions
of stage temperature control
meter:

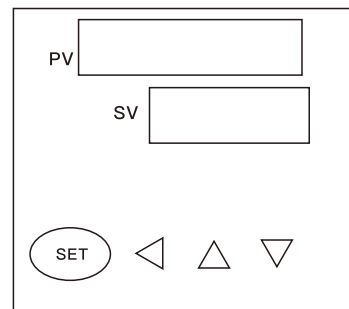

保护温控表简易操作说明：
Simple operation instructions
for protection temperature
control meter

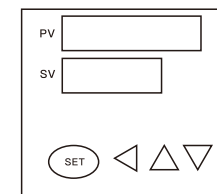

Pv: 本机工作状态下显示的实际温度; 在设置状态中显示所需设置参数。

Sv: 本机工作状态下显示预先设置的期望温度; 在设置状态中显示所需设置参数数值。

SET键: 设置键, 设置本机工作温度与时间。

 : 工作时作为待机键; 进入设置时作为移位键。

 : 在设置时作为增加键。

 : 在设置时作为减少键。

PV: The actual temperature which displayed in the working state of the machine; the required setting parameters are displayed in the setting state.

SV: Display the preset expected temperature under the working state of the machine; display the required setting parameter value in the setting state.

SET key: set the working temperature and time of the machine.

 : Used as a standby key when working; as a shift key when entering settings.

 : Used as an increase key during setting.

 : Used as a decrease key during setting.

本表为单段温控表, 只需设置本机使用到的最高温度即可

Pv: 本机工作状态下显示的实际温度。

SV: 本机工作状态下显示预先设置的期望温度。

SET键: 设置键, 设置本机工作温度。

 : 工作时作为待机键; 进入设置时作为移位键。

 : 在设置时作为增加键。

 : 在设置时作为减少键。

This meter is a single-stage temperature control meter, only need to set the highest temperature used by the machine

PV: The actual temperature displayed when the machine is working.

SV: The preset expected temperature is displayed when the machine is working.

SET key: set the working temperature.

 : Used as a standby key when working; as a shift key when entering settings.

 : Used as an increase key during setting.

 : Used as a decrease key during setting.